

MKCS/MKCP KVM

Integrated Matrix Cat6 KVM Switch
3 Type User Console (Local, Remote, IP)
1U Rackmount KVM Switch

Rack Consoles

User Manual

Integrated Matrix Cat6 KVM Switch

Legal Information

First English printing, June 2021

Information in this document has been carefully checked for accuracy; however, no guarantee is given to the correctness of the contents. The information in this document is subject to change without notice. We are not liable for any injury or loss that results from the use of this equipment.

Safety Instructions

Please read all of these instructions carefully before you use the device. Save this manual for future reference.

- Unplug equipment before cleaning. Don't use liquid or spray detergent; use a moist cloth.
- Keep equipment away from excessive humidity and heat. Preferably, keep it in an air-conditioned environment with temperatures not exceeding 40° Celsius (104° Fahrenheit).
- When installing, place the equipment on a sturdy, level surface to prevent it from accidentally falling and causing damage to other equipment or injury to persons nearby.
- When the equipment is in an open position, do not cover, block or in any way obstruct the gap between it and the power supply. Proper air convection is necessary to keep it from overheating.
- Arrange the equipment's power cord in such a way that others won't trip or fall over it.
- If you are using a power cord that didn't ship with the equipment, ensure that it is rated for the voltage and current labeled on the equipment's electrical ratings label. The voltage rating on the cord should be higher than the one listed on the equipment's ratings label.
- Observe all precautions and warnings attached to the equipment.
- If you don't intend on using the equipment for a long time, disconnect it from the power outlet to prevent being damaged by transient over-voltage.
- Keep all liquids away from the equipment to minimize the risk of accidental spillage. Liquid spilled on to the power supply or on other hardware may cause damage, fire or electrical shock.
- Only qualified service personnel should open the chassis. Opening it yourself could damage the equipment and invalidate its warranty.
- If any part of the equipment becomes damaged or stops functioning, have it checked by qualified service personnel.

What the warranty does not cover

- Any product, on which the serial number has been defaced, modified or removed.
- Damage, deterioration or malfunction resulting from:
 - Accident, misuse, neglect, fire, water, lightning, or other acts of nature, unauthorized product modification, or failure to follow instructions supplied with the product.
 - Repair or attempted repair by anyone not authorized by us.
 - Any damage of the product due to shipment.
 - Removal or installation of the product.
 - Causes external to the product, such as electric power fluctuation or failure.
 - Use of supplies or parts not meeting our specifications.
 - Normal wear and tear.
 - Any other causes which does not relate to a product defect.
- Removal, installation, and set-up service charges.

Regulatory Notices Federal Communications Commission (FCC)

This equipment has been tested and found to comply with the limits for a Class B digital device, pursuant to Part 15 of the FCC rules. These limits are designed to provide reasonable protection against harmful interference in a residential installation.

Any changes or modifications made to this equipment may void the user's authority to operate this equipment. This equipment generates, uses, and can radiate radio frequency energy and, if not installed and used in accordance with the instructions, may cause harmful interference to radio communications.

However, there is no guarantee that interference will not occur in a particular installation. If this equipment does cause harmful interference to radio or television reception, which can be determined by turning the equipment off and on, the user is encouraged to try to correct the interference by one or more of the following measures:

- Re-position or relocate the receiving antenna.
- Increase the separation between the equipment and receiver.
- Connect the equipment into an outlet on a circuit different from that to which the receiver is connected.

Contents

< Part. 1 > Matrix Cat6 KVM Kit

MKCP1613	MKCP1624
MKCP3213	MKCP3224

1.1	Package Contents	P.1
1.2	KVM Port & Cat6 Dongle Connection	P.2
1.3	IP & Remote Console Connection	P.3-4
1.4	IP Console Setting	P.5
1.5	KVM Cascade	P.6
1.6	Specifications	P.7

< Part. 2 > Matrix Cat6 KVM

MKCS1602	MKCS1603	MKCS1604
MKCS3202	MKCS3203	MKCS3204

2.1	Package Contents	P.8-9
2.2	KVM Port & Cat6 Dongle Connection	P.10
2.3	Remote Console Connection	P.11-12
2.4	KVM Cascade	P.13
2.5	Specifications	P.14

< Part. 3 > Matrix Cat6 KVM Usage

3.1	KVM Button	P.15
3.2	Password	P.16
3.3	KVM OSD	P.17
3.4	KVM Hotkey & Remote Console Hotkey	P.18

MKCP1613 / MKCP3213
MKCP1624 / MKCP3224

- Receiver box for remote console x 1
- Power adapter w/ power cord (for receiver) x 1
- Combo KVM cable for receiver box x 1

KVM Rear Kit

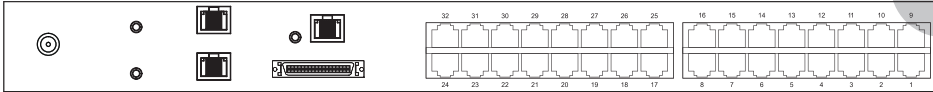

back



MKCP1613

Remote Console 1

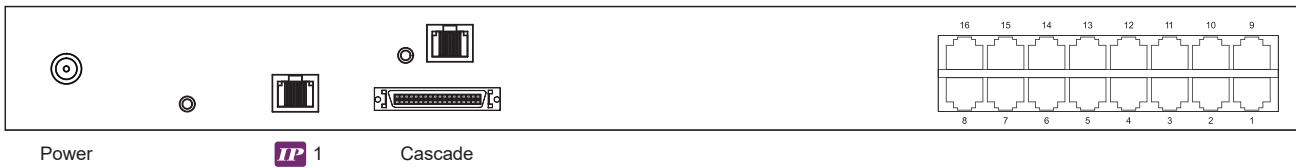

MKCP3213

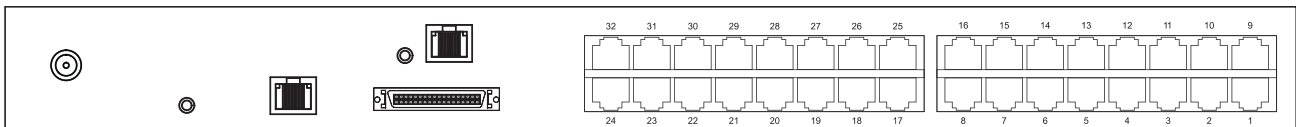

MKCP1624

IP 2

Remote Console 1

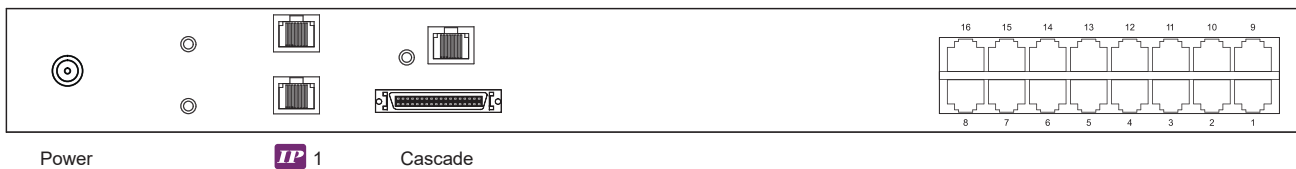

MKCP3224

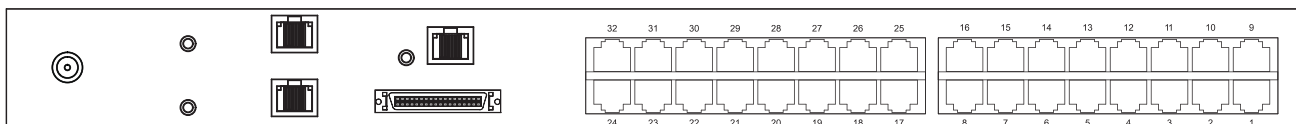

< 1.2 > KVM Port & Cat6 Dongle Connection

Matrix Cat6 IP KVM Kit

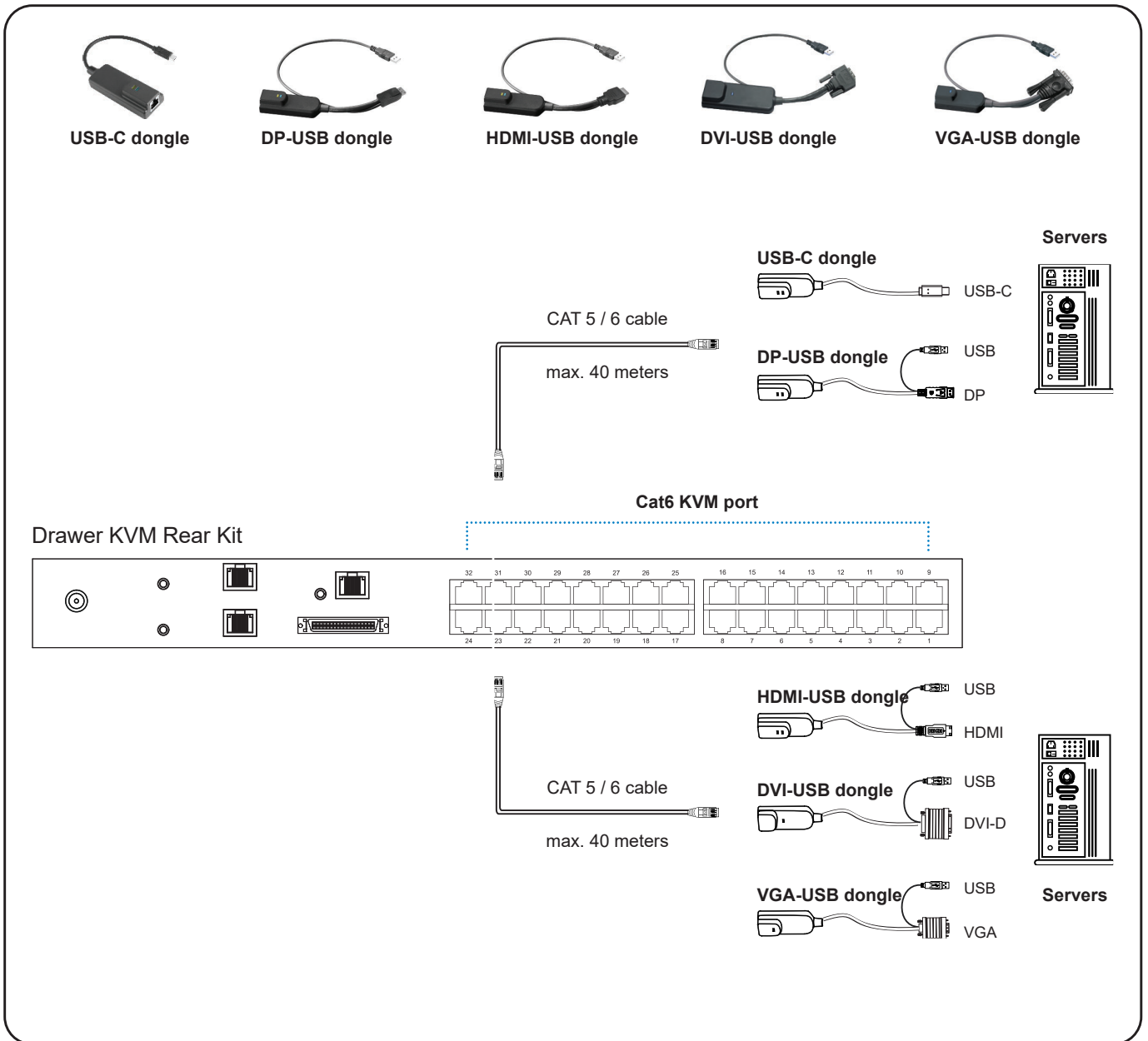

Cat6 Dongle

Resolution Support	Frequency (Hz)
1920 x 1080	60
1600 x 1200	60
1440 x 900	60
1280 x 1024	60
1024 x 768	60 / 70 / 75

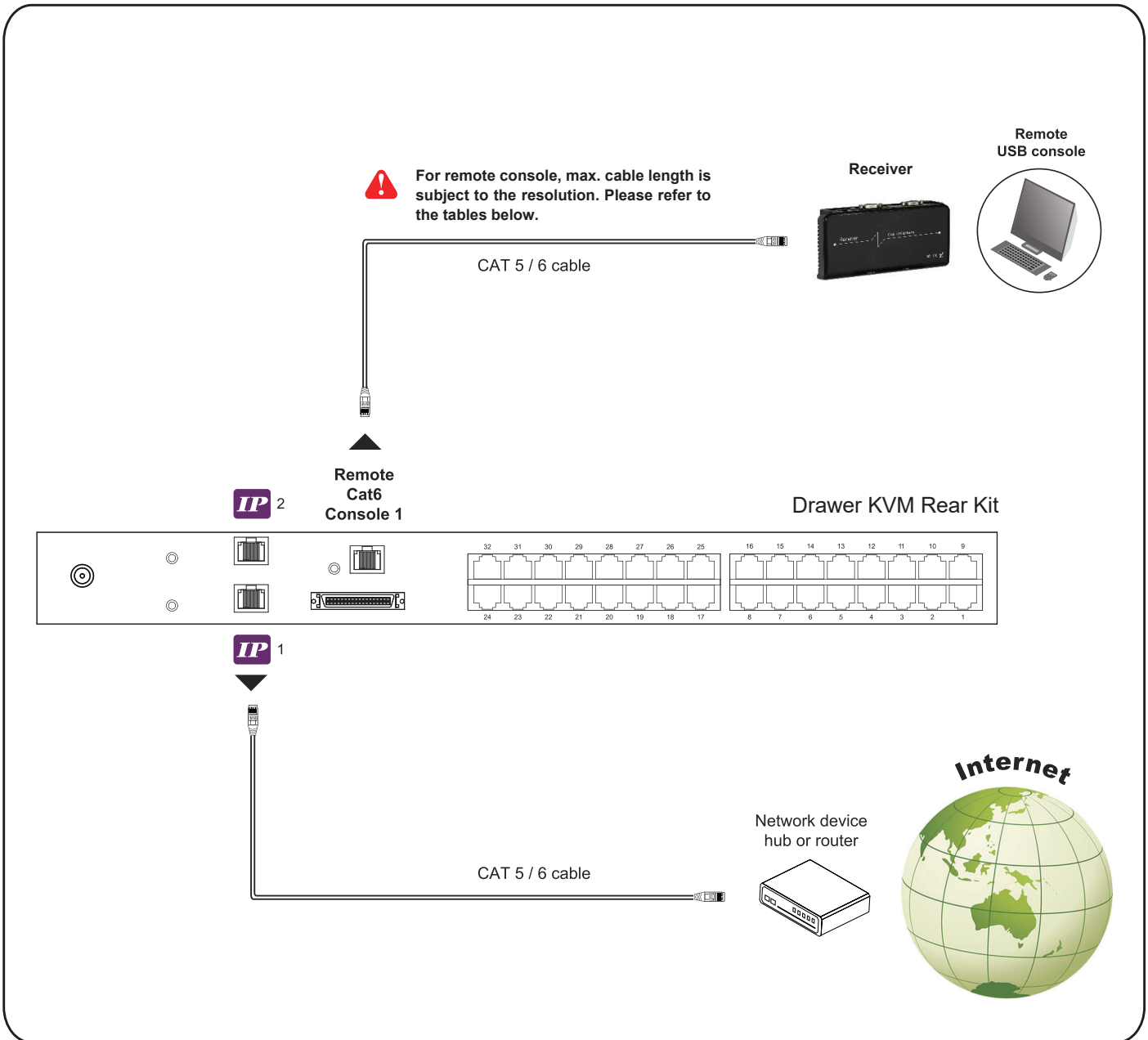

IP Console

Resolution Support	Frequency (Hz)
1600 x 1200	60
1280 x 1024	60
1024 x 768	60 / 70 / 75

Remote Console

Resolution Support	Frequency (Hz)	Max. Cat6 Cable Length (M)
1920 x 1080	60	50
1920 x 1200	60	50
1600 x 1200	60	100
1440 x 900	60	100
1280 x 1024	60	150
1024 x 768	60 / 70 / 75	150

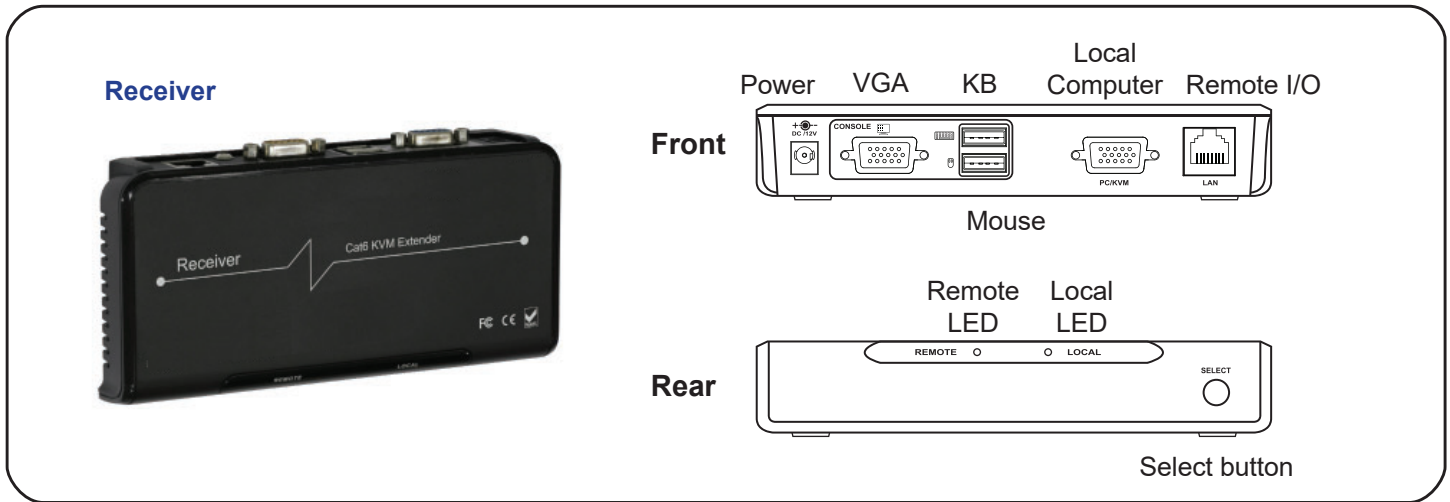

The receiver provides a hotkey function for remote console. Please refer to P.18

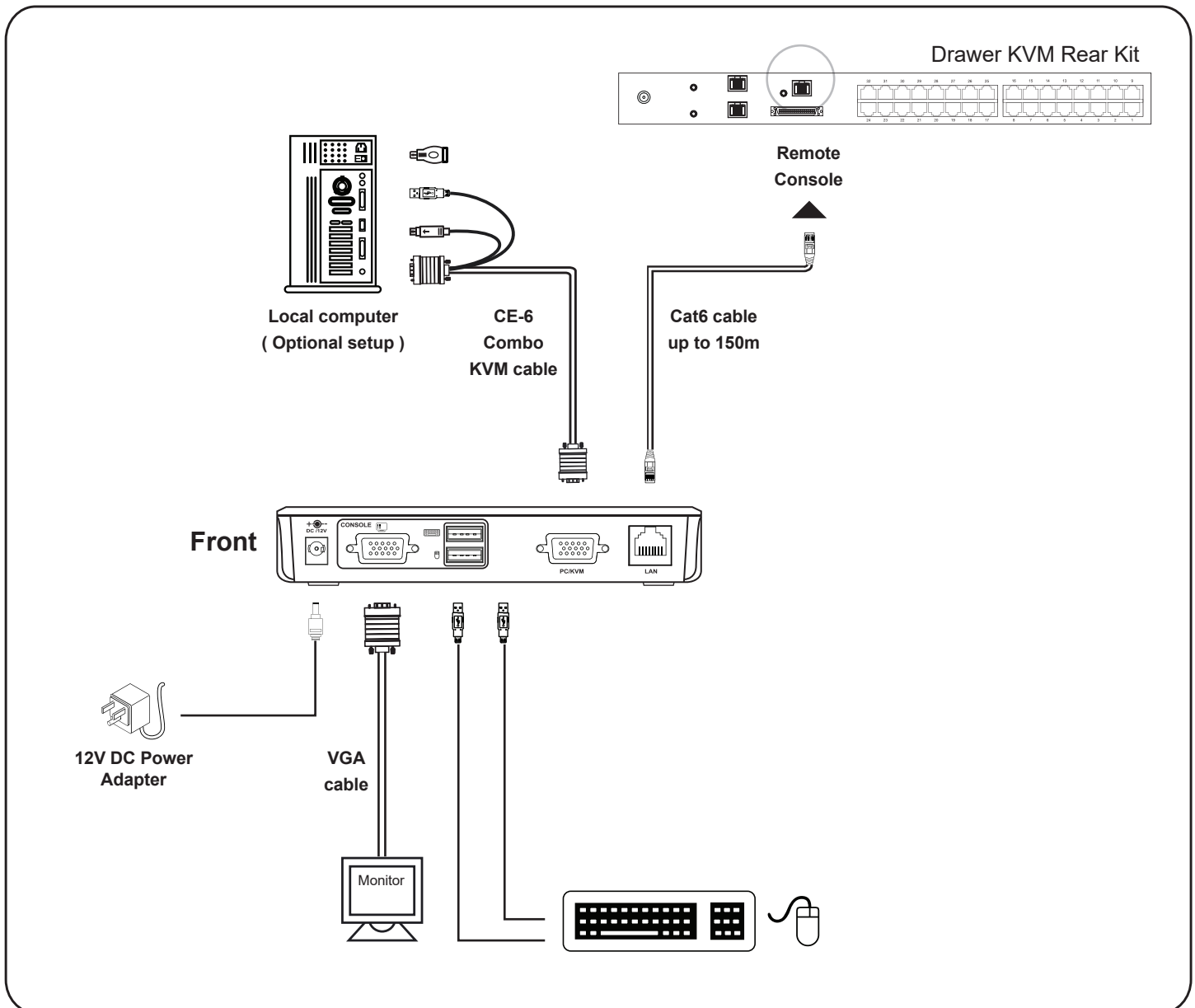

After the cable connection, please take the following steps to configure the IP KVM :

1. Download `IPKVMsetup.exe`
2. Double click `IPKVMsetup.exe` to configure the IP KVM by device setup as below.

3. Click **Refresh Device** to search the connected IP KVM
4. Select the M.A.C. address, which you want to setup, then click **Query Device**
5. Enter Super user login. **The default is super**
6. Enter Super user password. **The default is pass**
7. Enter the new super user password
8. Re-enter the new password
9. Change the desired IP address / Subnet mask / Gateway, then click **Setup Device** to confirm the setting to IP KVM
10. The default address is as below:--
 - The single IP KVM model, such as MKCP3213 - `http://192.168.1.22`
 - The dual IP KVM model, such as MKCP3224 - `http://192.168.1.22` (for 1st IP)
`http://192.168.1.23` (for 2nd IP)
11. Open Internet Explorer (I.E.), version 6.0 or above
12. Enter the IP KVM address into the address bar
 - For Single IP - `http://192.168.1.22`
 - For Dual IP - `http://192.168.1.22` (for 1st IP)
`http://192.168.1.23` (for 2nd IP)
13. Enter username (default is super)
Password (default is pass)
14. After successful login to IP KVM, the user will enter the main page of IP KVM



The setting is enough for intranet.

< 1.6 > KVM Cascade

Matrix Cat6 IP KVM Kit

- Cascade up to 8 levels, 256 servers
- Cascading multiple KVM with the 8ft Matrix KVM cascade cable.

! Cascaded KVMs from level 2 to 8 must be the models of MKCS1602 / MKCS3202 or MKS802 / MKS1602.

! When multiple matrix KVMs cascade together, the master KVM at level 1 will take all control of other slave KVM switches (e.g. level 2 to 8).

! The slave matrix KVM will be as a port expansion module of the master matrix KVM, the original remote console on slave KVM will be sacrificed and disabled.

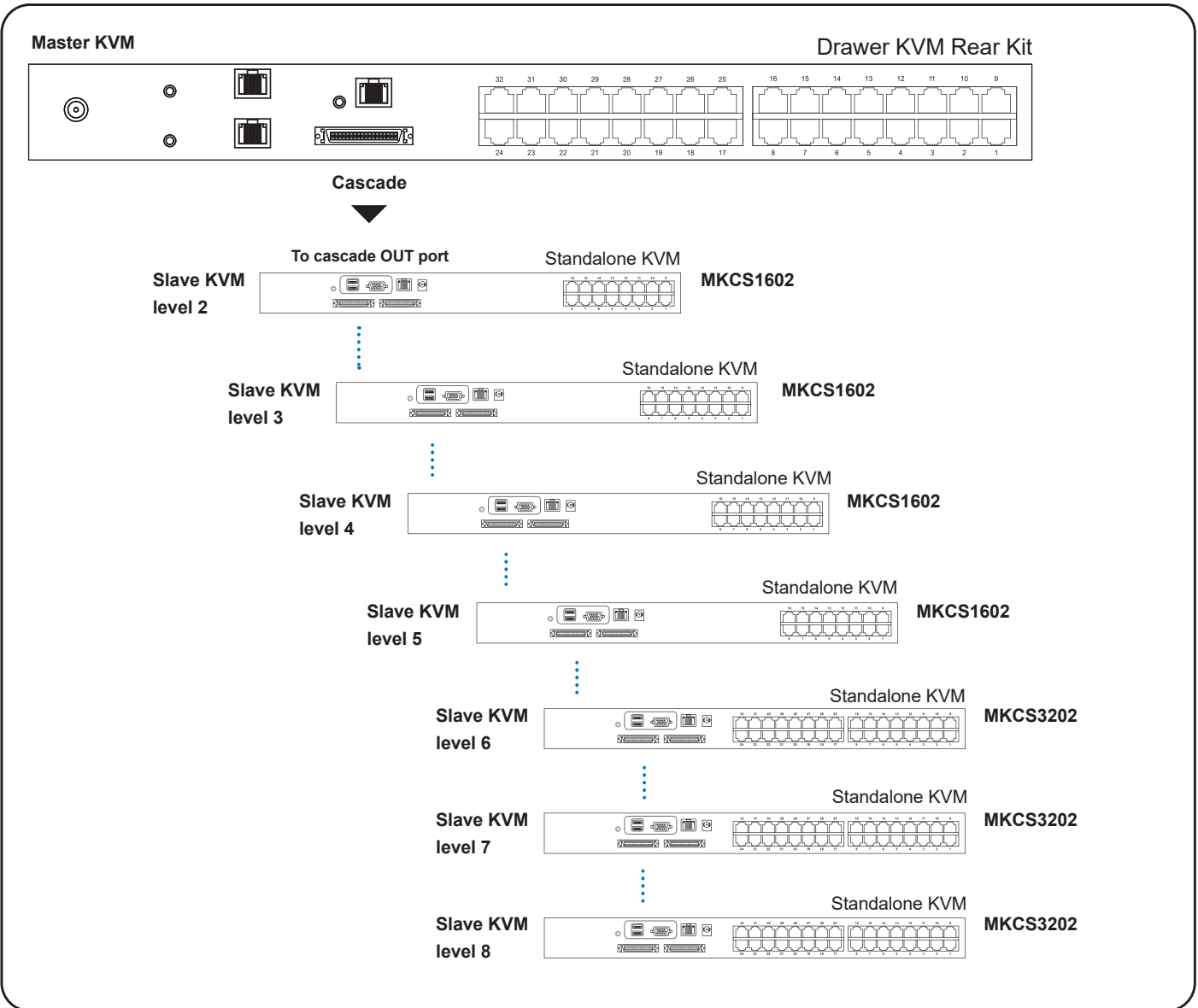

- 8ft Matrix KVM cascade cable

MKCP1613		MKCP1624	
MKCP3213		MKCP3224	
<p>■ KVM Port</p> <p>Number of ports : 16 or 32</p> <p>Connector : RJ-45</p> <p>Connectivity : DVI-D / VGA connector dongle up to 40 meters (132 feet) via Cat6 / Cat5 cable</p>			
<p>■ Local Console : Nil for LCD console drawer version</p>			
<p>■ Cat6 Remote Console</p> <p>Number of remote port : 1</p> <p>Monitor port : DB15-pin VGA</p> <p>Keyboard & mouse port : 2 x USB type connector for keyboard & mouse</p> <p>Remote I/O : RJ45 via Cat5 / Cat5e / Cat6 cable up to 500 feet</p> <p>Resolution support : 16:9 - max. 1920 x 1080 16:10 - max. 1920 x 1200 4:3 - max. 1600 x 1200</p>			
<p>■ IP Remote Console</p> <p>Number of IP console : 1 for -MKCP1613 / -MKCP3213 2 for -MKCP1624 / -MKCP3224</p> <p>User management : 15-user login, 1 x active user</p> <p>Browser : Internet Explorer, Firefox, Safari</p> <p>Security : SSL v3, RSA, AES, HTTP / HTTPS, CSR</p> <p>IP Access : RJ45 Ethernet per IP console</p> <p>Resolution support : 4:3 - max. 1600 x 1200</p>			
<p>■ Expansion : Up to 256 servers by 8-level cascade</p>			
<p>■ Compatibility</p> <p>Hardware : HP / IBM / Dell PC, Server and Blade Server SUN / Mac</p> <p>OS Support : Windows / Linux / Unix / Mac OS</p>			
<p>■ Power</p> <p>Input : AC power adapter</p> <p>Consumption : Max. 34W</p>			
<p>■ Regulatory</p> <p>Safety : FCC & CE certified</p> <p>Environment : RoHS3 & REACH compliant</p>			
<p>■ Environmental</p>		<p>Operating</p>	<p>Storage / Non-operating</p>
Temperature :	0 to 55°C degree	-20 to 60°C degree	
Humidity :	20~90%, non-condensing	5~90%, non-condensing	
Altitude :	16,000 ft	40,000 ft	
Shock :	-	10G acceleration (11ms duration)	
Vibration :	-	10~300Hz 0.5G RMS random vibration	

< Part 2 > Matrix Cat6 KVM
< 2.1 > Package Contents

MKCS1602 / MKCS3202

- Receiver box for remote console x 1
- Power adapter w/ power cord (for receiver) x 1
- 6ft Combo KVM cable for receiver box x 1

KVM Rear Kit

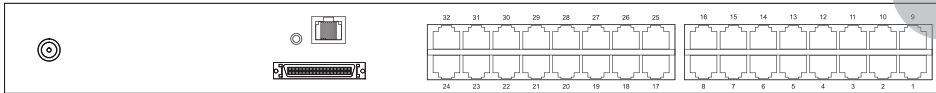

MKCS1603 / MKCS3203

- Receiver box for remote console x 2
- Power adapter w/ power cord (for receiver) x 2
- 6ft Combo KVM cable for receiver box x 2

KVM Rear Kit

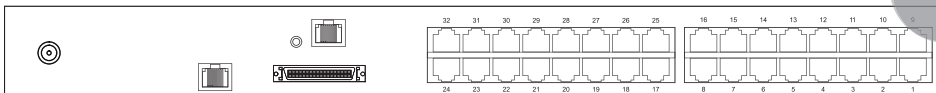

MKCS1604 / MKCS3204

- Receiver box for remote console x 3
- Power adapter w/ power cord (for receiver) x 3
- CE-6 6ft Combo KVM cable for receiver box x 3

KVM Rear Kit

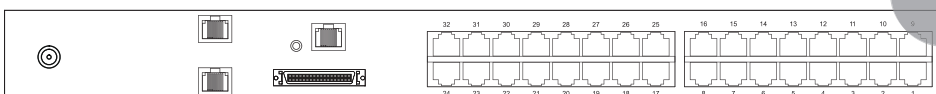

MKCS1602

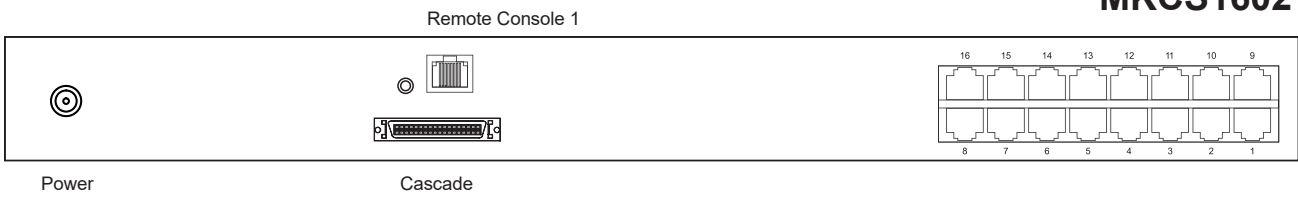

MKCS3202

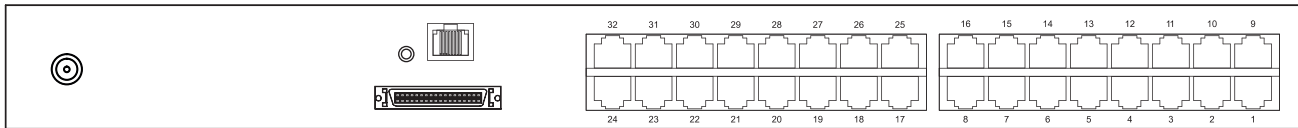

MKCS1603

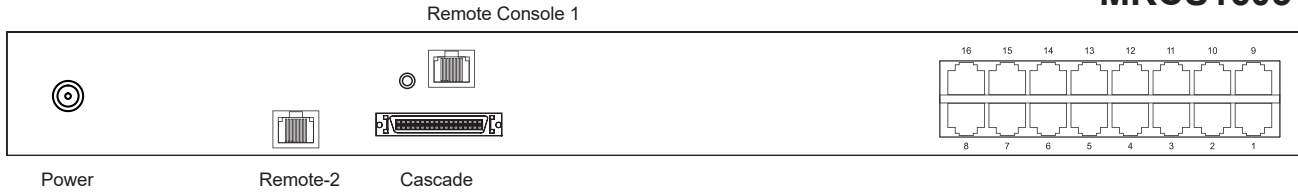

MKCS3203

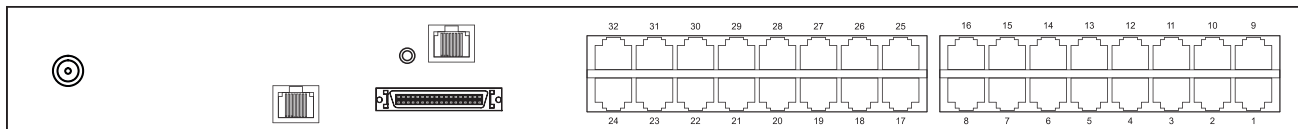

MKCS1604

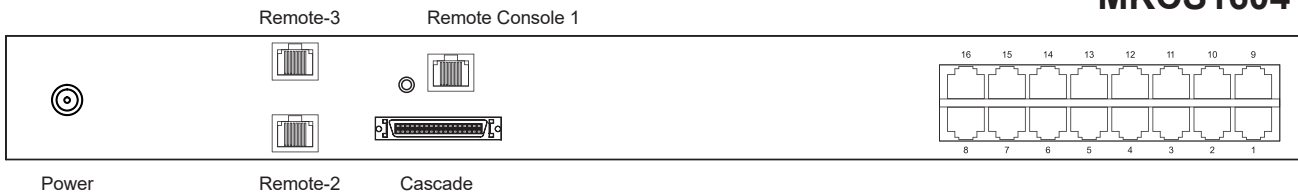

MKCS3204

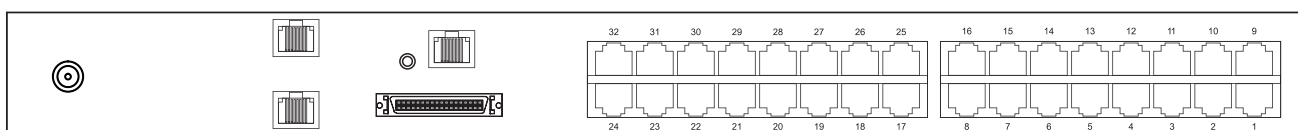

< 2.2 > KVM Port & Cat6 Dongle Connection

Matrix Cat6 KVM

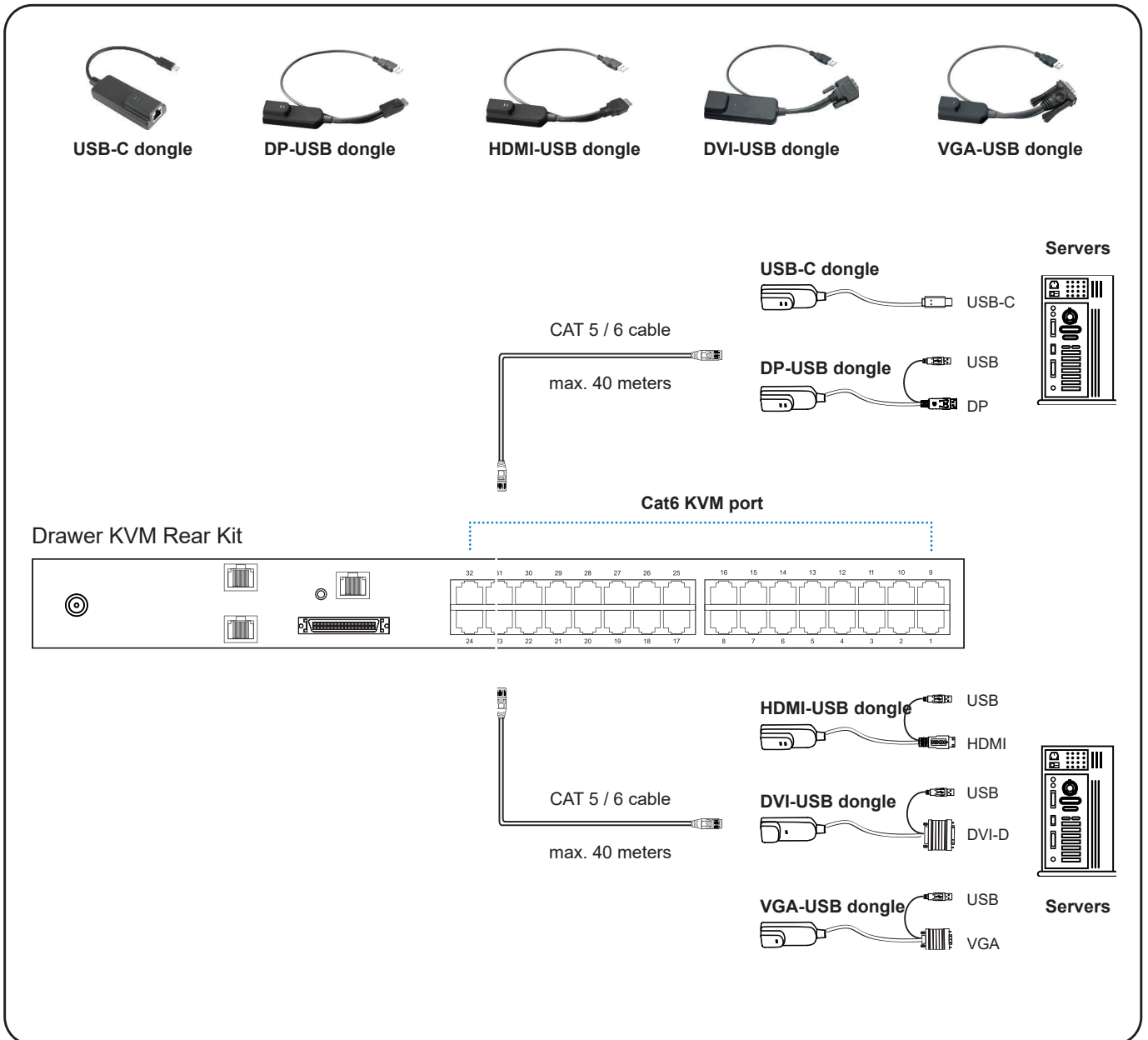

Cat6 Dongle

Resolution Support	Frequency (Hz)
1920 x 1080	60
1600 x 1200	60
1440 x 900	60
1280 x 1024	60
1024 x 768	60 / 70 / 75

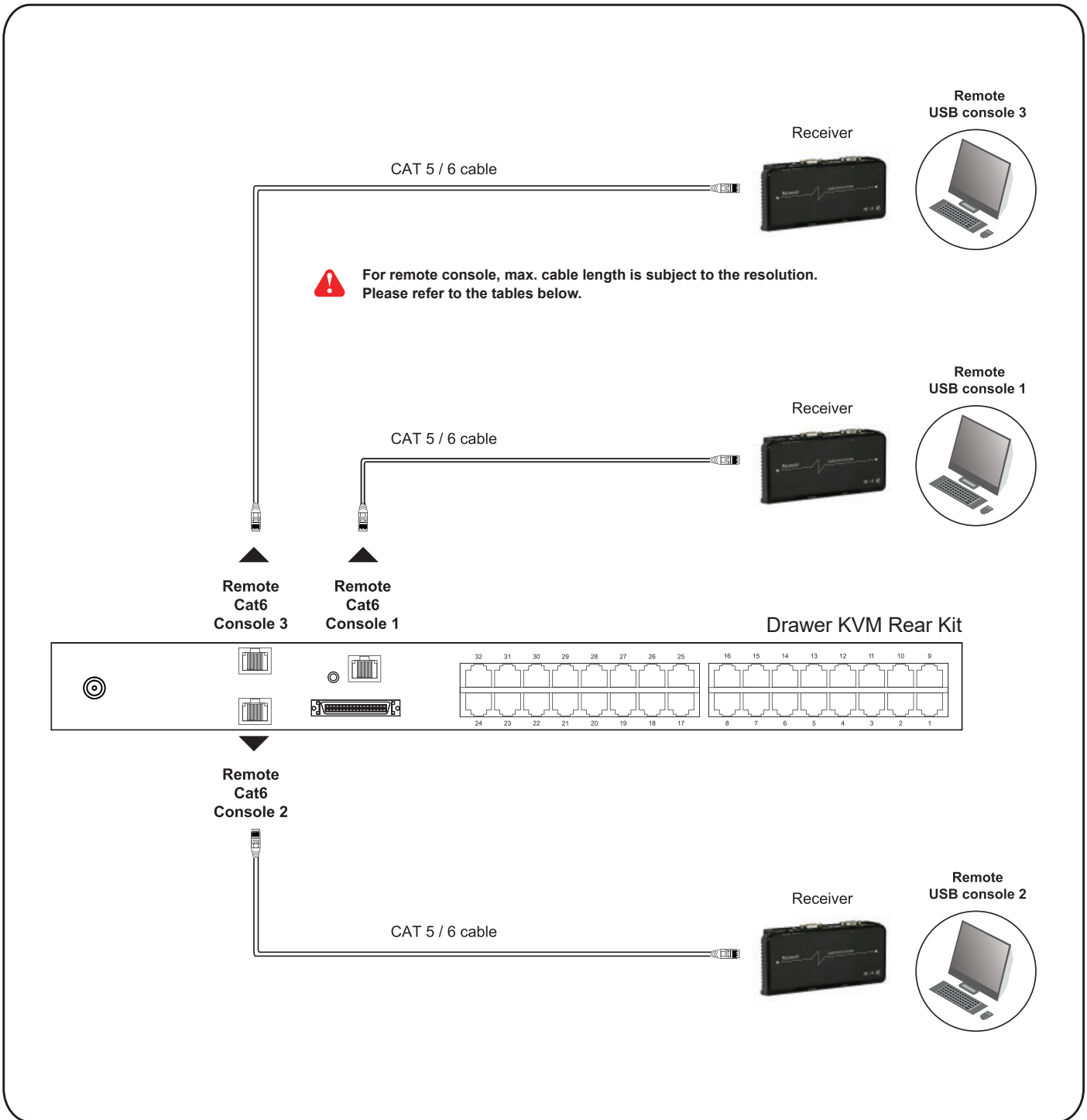

Remote Console

Resolution Support	Frequency (Hz)	Max. Cat6 Cable Length (M)
1920 x 1080	60	50
1920 x 1200	60	50
1600 x 1200	60	100
1440 x 900	60	100
1280 x 1024	60	150
1024 x 768	60 / 70 / 75	150

Receiver

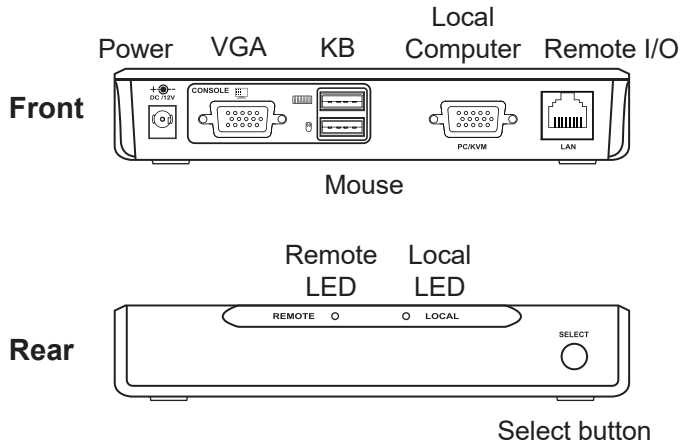

The receiver provides a hotkey function for remote console. Please refer to P.18

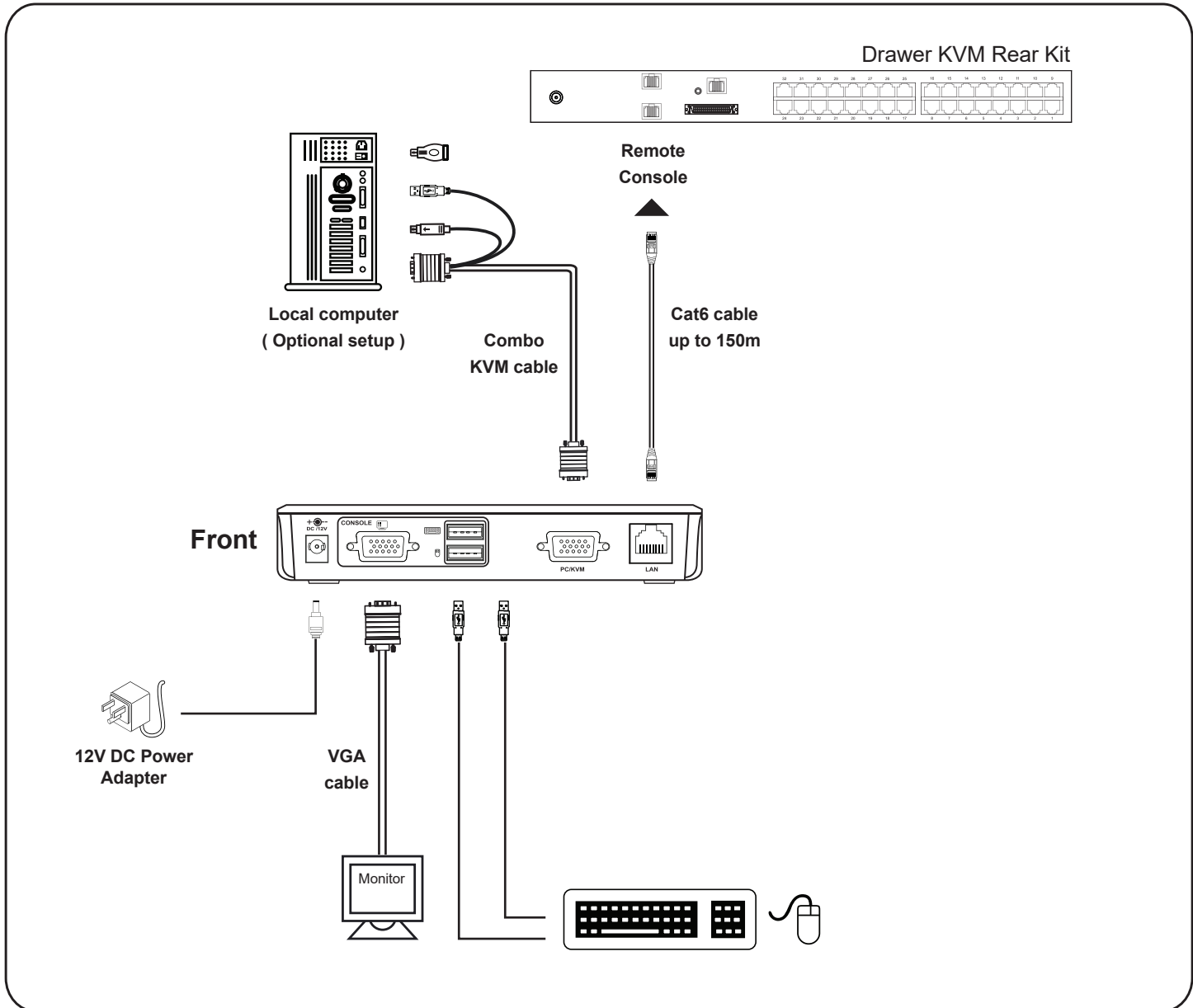

< 2.4 > KVM Cascade

- Cascade up to 8 levels, 256 servers
- Cascading multiple KVM with the 8ft Matrix KVM cascade cable.

! Cascaded KVMs from level 2 to 8 must be the models of MKCS1602 / MKCS3202 or MKS802 / MKS1602.

! When multiple matrix KVMs cascade together, the master KVM at level 1 will take all control of other slave KVM switches (e.g. level 2 to 8).

! The slave matrix KVM will be as a port expansion module of the master matrix KVM, the original remote console on slave KVM will be sacrificed and disabled.

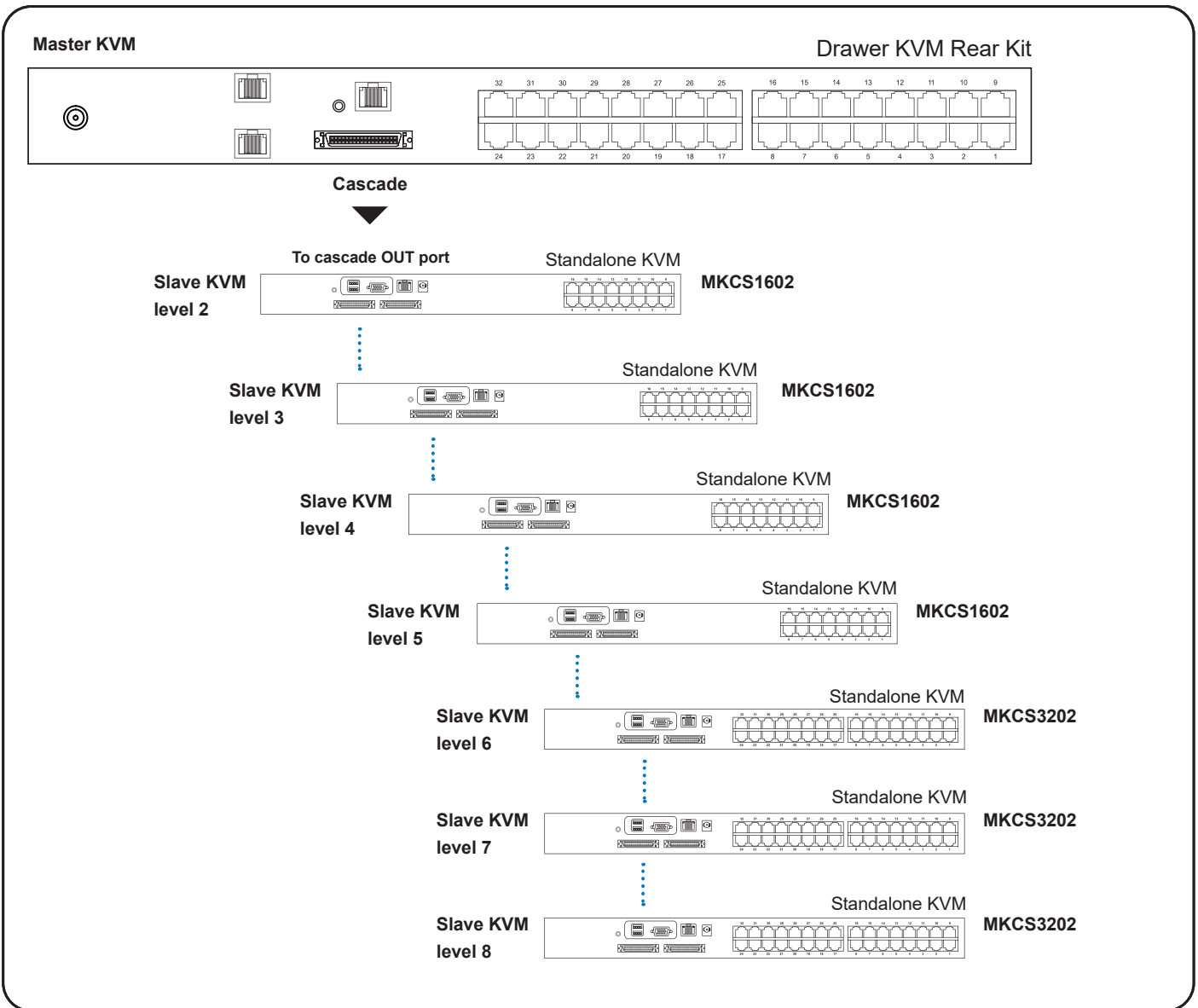

■ 8ft Matrix KVM cascade cable

	MKCS1602 MKCS3202	MKCS1603 MKCS3203	MKCS1604 MKCS3204
<p>■ KVM Port</p> <p>Number of ports : 16 or 32</p> <p>Connector : RJ-45</p> <p>Connectivity : DVI-D / VGA connector dongle up to 40 meters (132 feet) via Cat6 / Cat5 cable</p>			
<p>■ Local Console :</p> <p>Nil for LCD console drawer version</p>			
<p>■ Cat6 Remote Console</p> <p>Number of remote port : 1 for -MKCS1602 / -MKCS3202 2 for -MKCS1603 / -MKCS3203 3 for -MKCS1604 / -MKCS3204</p> <p>Monitor port : DB15-pin VGA</p> <p>Keyboard & mouse port : 2 x USB type connector for keyboard & mouse</p> <p>Remote I/O : RJ45 via Cat5 / Cat5e / Cat6 cable up to 500 feet</p> <p>Resolution support : 16:9 - max. 1920 x 1080 16:10 - max. 1920 x 1200 4:3 - max. 1600 x 1200</p>			
<p>■ Expansion :</p> <p>Up to 256 servers by 8-level cascade</p>			
<p>■ Compatibility</p> <p>Hardware : HP / IBM / Dell PC, Server and Blade Server SUN / Mac</p> <p>OS Support : Windows / Linux / Unix / Mac OS</p>			
<p>■ Power</p> <p>Input : AC power adapter</p> <p>Consumption : Max. 20W</p>			
<p>■ Regulatory</p> <p>Safety : FCC & CE certified</p> <p>Environment : RoHS3 & REACH compliant</p>			
<p>■ Environmental</p> <p>Temperature : 0 to 55°C degree</p> <p>Humidity : 20~90%, non-condensing</p> <p>Altitude : 16,000 ft</p> <p>Shock : -</p> <p>Vibration : -</p>	<p>Operating</p> <p>0 to 55°C degree</p> <p>20~90%, non-condensing</p> <p>16,000 ft</p> <p>-</p> <p>-</p>	<p>Storage / Non-operating</p> <p>-20 to 60°C degree</p> <p>5~90%, non-condensing</p> <p>40,000 ft</p> <p>10G acceleration (11ms duration)</p> <p>10~300Hz 0.5G RMS random vibration</p>	

Power ON

- Turn off all servers and KVM switches
- Make sure all cables / connectors are properly connected
- Recommend Power ON sequence is monitor, KVM switch finally computer

Front Panel - Port LED Indications

16 ports

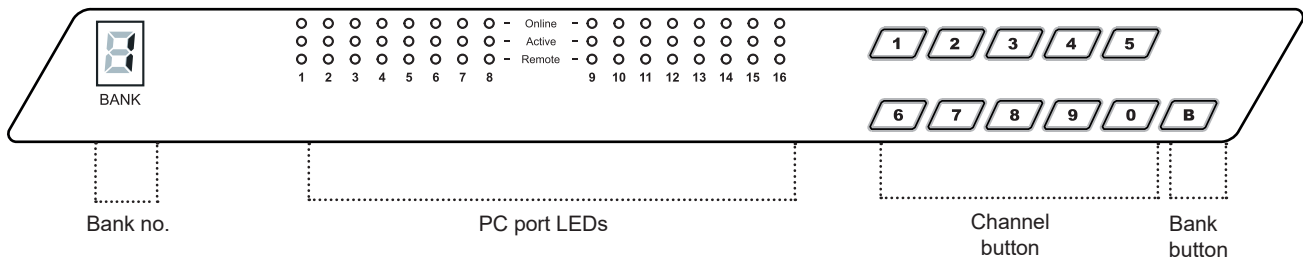

32 ports

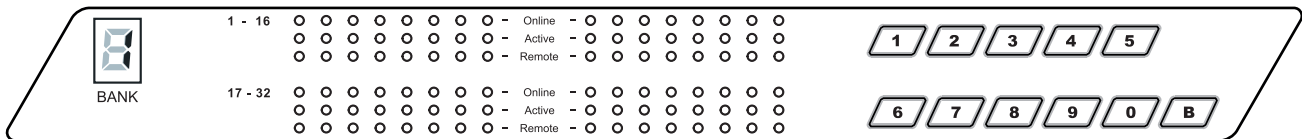

Bank no.	7-Segment BANK LED indication
PC port LEDs	<p>Online : Blue LED on indicating a PC is connecting to the port</p> <p>Active : Green LED on indicating a selected channel</p> <p>Remote : Orange LED on indicating the port is selecting by IP / remote console</p>
Channel button	Press to select channel from 01 to 32
Bank button	Select the bank from 1 to 8

The password is enabled by default, the default password is “00000000” eight zeros (**Do not use “0” on number pad**)

■ Enable password

1. Press the KVM hotkey **Scroll Lock + Scroll Lock + U**
2. Logout the KVM by pressing the hotkey **Scroll Lock + Scroll Lock + P**
3. In SUPERVISOR level, enter “00000000” eight zeros in user name & password field (**Do not use “0” on number pad**)
4. In USER level, press **Space bar + Enter** in user name & password field
Remark: Automatic logout after 10 minutes of inactivity

■ Set your own user name & password

1. Login the KVM in SUPERVISOR level by pressing “00000000” eight zeros in user name & password field
2. Call KVM OSD menu by pressing the KVM hotkey **Scroll Lock + Scroll Lock + Space Bar**
3. Press **F1** to the MAIN MENU
4. Select “USER SECURITY”
5. Set password in SUPERVISOR & USER level
 - a. In the left-top row “S” (SUPERVISOR), press **Enter** to set your own user name & password
 - b. In the row 1 to 8 (USER), press **Enter** to set your own user name & password
6. Press **Enter** to save the setting or press **Esc** to cancel the editing without any change
Remark: a. Blank has underscore, while SPACE doesn't have
 - b. Press any alphanumeric key to move to next input item. SPACE is treated as a valid character

■ Change your password

1. Login the KVM in SUPERVISOR level by pressing your own user name & password
2. Call KVM OSD menu by pressing the KVM hotkey **Scroll Lock + Scroll Lock + Space Bar**
3. Press **F1** to the MAIN MENU
4. Select “USER SECURITY”
5. Change password in SUPERVISOR & USER level
 - a. In the left-top row “S” (SUPERVISOR), press **Enter** to change your user name & password
 - b. In the row 1 to 8 (USER), press **Enter** to change your user name & password
6. Press **Enter** to save the setting or press **Esc** to cancel the editing without any change
Remark: a. Blank has underscore, while SPACE doesn't have
 - b. Press any alphanumeric key to move to next input item. SPACE is treated as a valid character

■ Disable your password

1. Press the KVM hotkey **Scroll Lock + Scroll Lock + U**
2. Logout the KVM by pressing the KVM hotkey **Scroll Lock + Scroll Lock + P**
3. You don't need user name & password to access the KVM OSD menu

■ Forget your password

Please contact your supplier for further support



Remark:

- You must press the KVM hotkey within 2 seconds
- A beep sound will be heard for successful entering KVM hotkey

OSD Menu

PORT NAME	
BANK : 1	
01☼ SYSTEM 01	F1 : MENU
02☼ SYSTEM 02	F2 : LOGOUT
03☼ SYSTEM 03	F3 : PREV
04☼ SYSTEM 04	ESC : QUIT
05☼ SYSTEM 05	ENTER : COMPLETE
06☼ SYSTEM 06	↑/↓ : SELECT
07☼ SYSTEM 07	PgUp/PgDn : BANK SELECT
08☼ SYSTEM 08	
USER : SUPERVISOR	
SCAN TIME : 10 SEC	
FW1V3	

OSD operation

 next to the system name	The PC is powered on
 next to the system name	The PC is selected
F1	Access F1 MAIN MENU
F2	Logout the OSD menu
F3	Previous menu
Esc	Cancel / Quit
Enter	Complete / Switch to selected port
↑/↓	Switch to previous or next port
PgUp/PgDn	Switch to previous bank or next bank
1 / 2 / 3 / 4	Display port 01 ~ 08 / 09 ~ 16 / 17 ~ 24 / 25 ~ 32 Remark: Display port 17 ~ 32 for 32 port model only

F1 Main Menu

MAIN MENU	
SELECT OPTION :	
01	LANGUAGE
02	PORT NAME EDIT
03	PORT SEARCH
04	USER SECURITY
05	ACCESS LIST
06	HOTKEY
07	TIME SETTINGS
08	OSD MOUSE

01 LANGUAGE	OSD language change
02 PORT NAME EDIT	Define port name
03 PORT SEARCH	Quick searching by port name
04 USER SECURITY	Change password
05 ACCESS LIST	Define user access authority
06 HOTKEY	Change hotkey
07 TIME SETTINGS	Modify scan display time interval
08 OSD MOUSE	Modify OSD mouse speed

Local Console Hotkey	Function
Scroll Lock + Scroll Lock + Space Bar	Calling OSD menu
Right-button mouse + Esc	Calling OSD menu
Scroll Lock + Scroll Lock + ↑	Switch to previous port
Scroll Lock + Scroll Lock + ↓	Switch to next port
Scroll Lock + Scroll Lock + PgUp / PgDn	Switch to previous bank or next bank
Scroll Lock + Scroll Lock + Bank no. + Port no.	Switch to specific port
Scroll Lock + Scroll Lock + B	Turn the buzzer ON and OFF * Default the buzzer is ON
Scroll Lock + Scroll Lock + P	Logout the KVM if password security is ON. Show up the status windows

Advance hotkeys (for Supervisor login only)

Scroll Lock + Scroll Lock + S	Activate auto-scan mode for connected servers *Press any key to exit the auto-scan mode
Scroll Lock + Scroll Lock + R	Reset all the KVM settings to factory default *Except User Security settings
Scroll Lock + Scroll Lock + U	Disable and enable password security *Default security is ON
Scroll Lock + Scroll Lock + L	To enable / disable the screen saving function and 10 minutes auto-logout *Default the screen saving is OFF

Remarks: ■ Example of “Scroll Lock + Scroll Lock + Bank no. + Port no.”

- Bank No. : 1 to 8
- Port No. : 01 to 16
- e.g. Bank 1 Port 4 : **Scroll Lock + Scroll Lock + 1 + 0 + 4**
- e.g. Bank 2 Port 16 : **Scroll Lock + Scroll Lock + 2 + 1 + 6**
- You must press the hotkey within 2 seconds
- A beep sound will be heard for successful entering
- The numeric keypad is not supported, while in OSD screen, the arrow keys, PgUp, PgDn, and Enter keys are supports

Remote Console Hotkey	Function
Scroll Lock + Scroll Lock + C	Toggle switch between remote & local port
Scroll Lock + Scroll Lock + Q	Turn the buzzer ON & OFF *Default the buzzer is ON
Scroll Lock + Scroll Lock + S	Activate auto-scan mode for remote & local port *The scan time interval is 5 seconds
Scroll Lock + Scroll Lock + A	Auto-adjust the video signal